

Installation And Care Instructions

Silhouette® Window Shadings

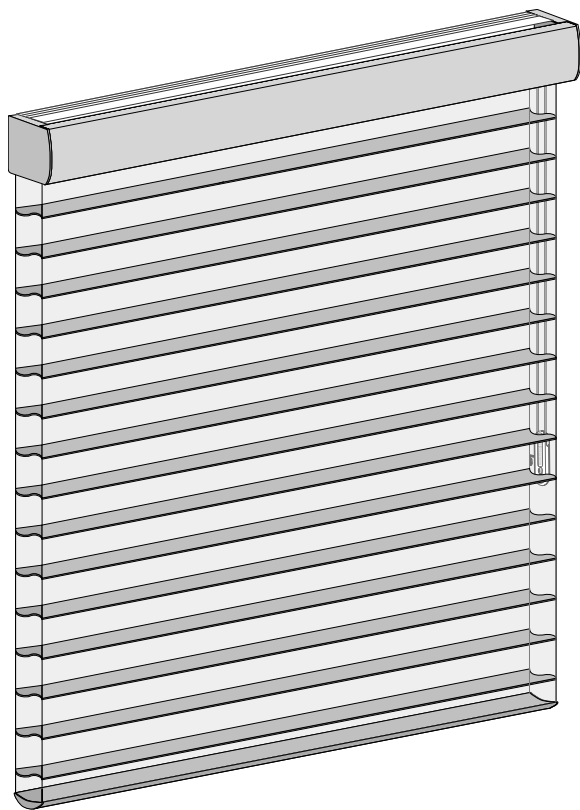

Standard Rectangular Shadings

HunterDouglas
window fashions

THANK YOU for purchasing a Hunter Douglas product. Your new window shading has been custom built for you from the highest quality materials. Once in your window, it will provide you with a lifetime of beauty and trouble-free use.

Getting Started

- Remove the window shading from the package. Keep the packaging until the shading operates to your satisfaction.
- Check the diagram to make sure you have the necessary parts.

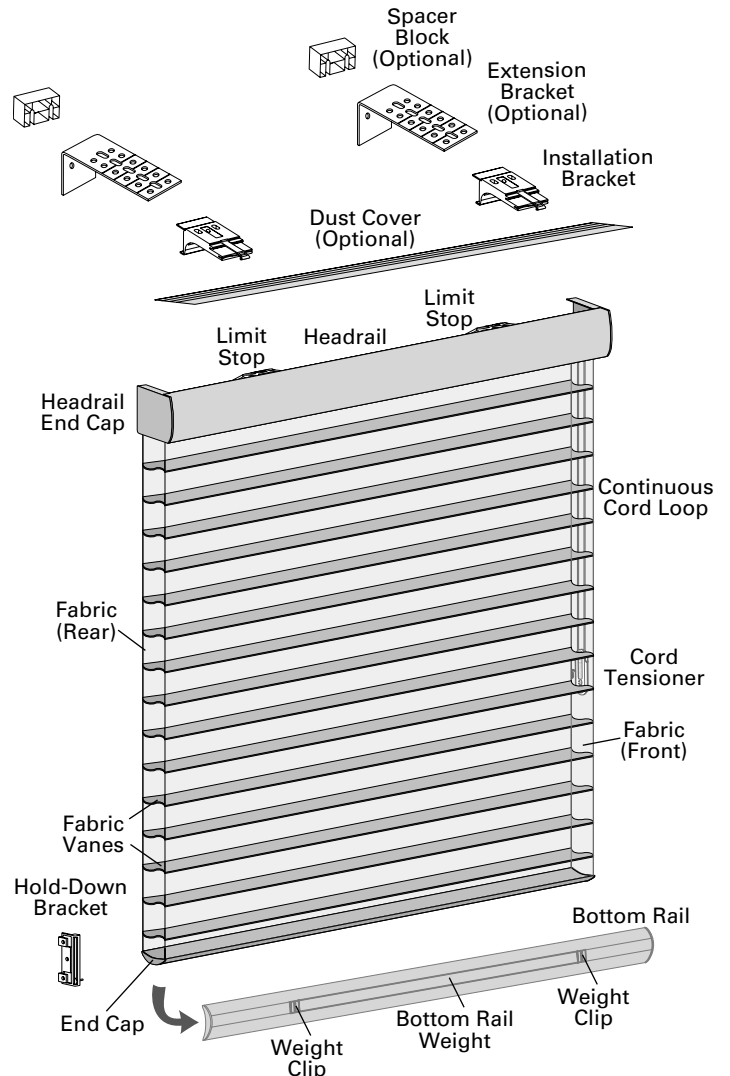

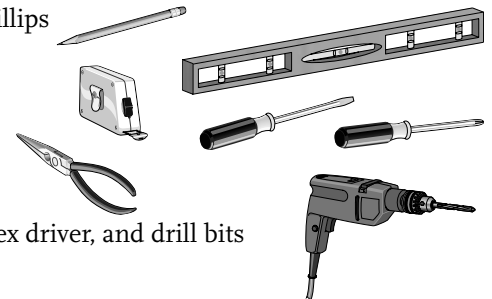

Tools needed for installing your Silhouette® shading:

- Flat blade and Phillips screwdrivers
- Level
- Measuring tape
- Pencil
- Pliers
- Power drill, 1/4" hex driver, and drill bits



For assistance, call the Hunter Douglas
Customer Information Center
at 1-888-501-8364
Visit our Web site at hunterdouglas.com

In addition, you will need fasteners designed to work with your specific mounting surfaces:

Mounting Surface	Fastener
Wood, Metal	No. 6 Hex Head Screws (Provided) 
Drywall, Plaster	Wall Anchors, Expansion Bolts (Not Provided) 
	Sheet Metal Screws (Not Provided) 

Contents of the hardware package may vary depending upon how the shading was ordered and whether the shading will be inside or outside mounted.

1 Mount The Installation Brackets

Bracket Placement

- Measure 2" in from the ends of the headrail and mark the bracket location on the mounting surface.
- Bracket placement is the same for inside and outside mounts.

Normal Spacing (Shadings Over 36" Wide):

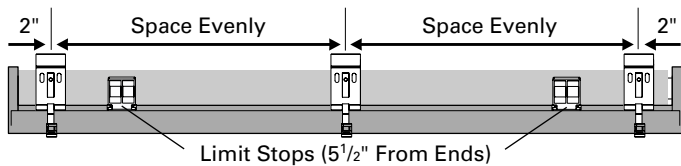

Obstruction Spacing (Maximum):

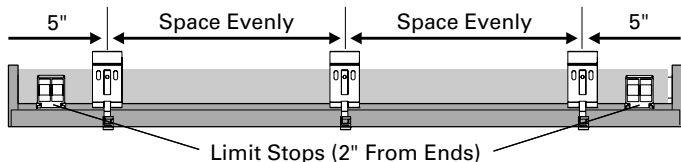

Shade Width	Brackets Required
12" - 36"	2
36 1/8" - 79"	3
79 1/8" - 96"	4
96 1/8" - 120"	5

Inside Mount Applications

Back Cover Bracket Installation (Optional)

- If using the back cover brackets, use pliers to break off both tabs on the installation brackets.
- Snap the prongs on the back cover brackets into the holes on the back of the installation brackets.

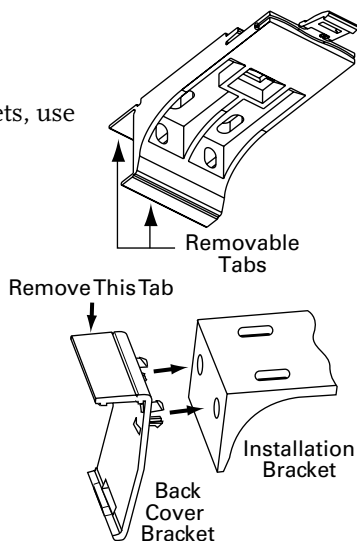

CAUTION: Do not push down on the limit stops. Limit stop angle is set at the factory. Over-adjusting the limit stop is not reversible and may damage the shading.

Bracket Installation

- Use pliers to break off the upper tab of each bracket.

NOTE: Remove the bottom tab on each installation bracket only if it interferes with the bracket installation.

- Center each bracket over a mark on the mounting surface.
- Adjust bracket placement to accommodate any obstructions to the bottom rail, such as window cranks or handles.
- Check that each bracket is level and the front edges are aligned. Attach using two screws.

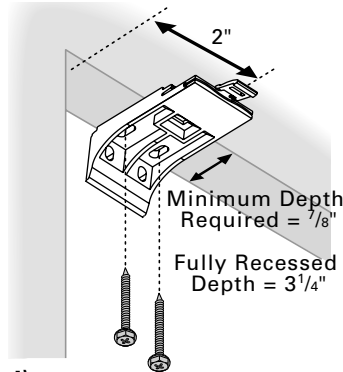

Back Cover Installation (Optional)

- After bracket installation, install the cover into the back bracket, as shown.

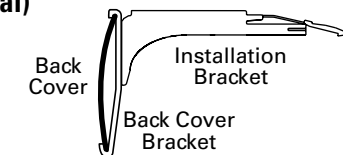

Outside Mount Applications

The outside mount minimum height is 3/4".

Bracket Installation

- Center the shading over the window and mark the ends of the headrail.
- Measure 2" in from the marks on the wall and mark the bracket locations.
- Use pliers to break off both tabs on each mounting bracket.
- Center each bracket over the marks on the mounting surface.
- Adjust bracket position to accommodate any obstructions to the bottom rail, such as window cranks or handles.
- Check that each bracket is level and the tops are aligned. Attach using two screws.

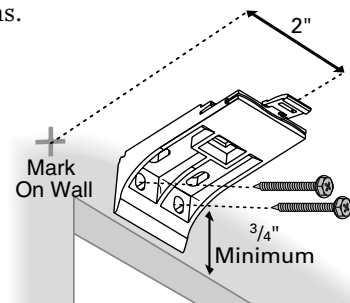

Spacer Blocks (Optional)

Each spacer block projects brackets 1/2" from the mounting surface.

- Mount spacer blocks with the solid side facing the mounting surface.
- Use two mounting screws. Screws should be long enough to secure the bracket to the mounting surface.
- Use a maximum of three spacer blocks per bracket.

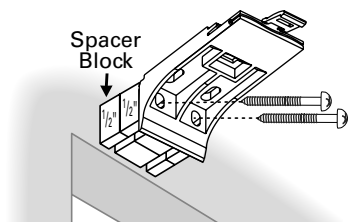

End Mount Applications

End mount the headrail when conventional mounting techniques will not work, for example, in an arched window.

- Mount the extension brackets on a surface at least 1 1/2" wide.
- Attach the installation brackets to the extension brackets using the machine screws and nuts provided.

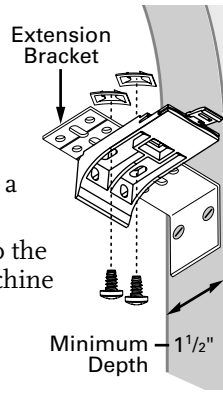

2 Install The Shading

- Remove the protective covering from the fabric-covered headrail.
- Hold the shading so the front faces you.
- Push the top edge of the headrail **under the locking tab** on the installation bracket until it snaps into place. The locking tab will be visible.

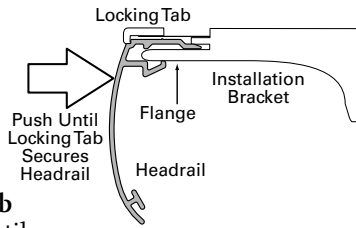

WARNING: Failure to snap the headrail securely into the installation bracket and engage the locking tab may cause the shading to release unexpectedly.

3 Operate The Shading

- Pull on the rear cord of the cord loop to lower the shading.
- With the shading fully lowered, continue to pull on the rear cord to tilt the bottom rail and open the vanes.
- Pull on the front cord of the cord loop to close the vanes and raise the shading.

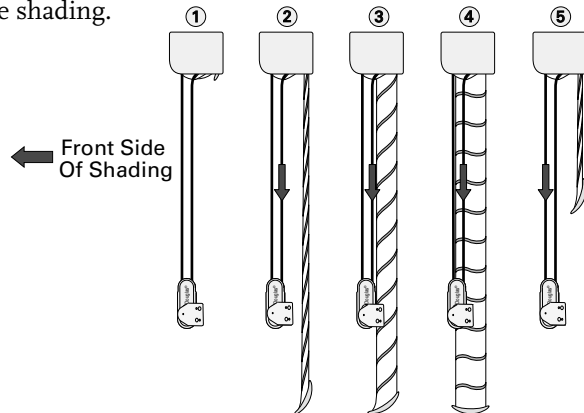

4 Adjust The Shading

Test The Shading

- Lower the shading, then slowly raise it.
- If the fabric rolls unevenly or rubs against the end cap, check that the headrail is level. Level, if necessary.
- If the headrail is level, adjust the bottom rail weight.

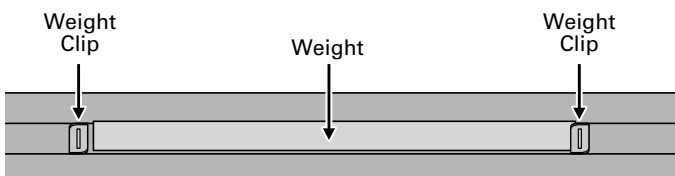

Adjust The Bottom Rail Weight

- To release, insert a flat blade screwdriver into a weight clip and turn clockwise.
- Move the weight in 1" increments toward the side where the fabric is gathering.

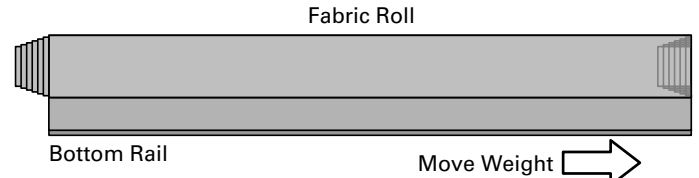
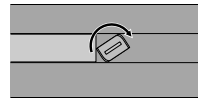

- Secure the weight clips in position by turning them counterclockwise after making the adjustment.
- Test and, if necessary, adjust again.

NOTE: Skew adjustment is not possible by moving the limit stop assemblies.

5 Attach The Accessories

Install The Cord Tensioner

See the Universal Cord Tensioner Installation Instructions.

Attach The Dust Cover (Optional)

- Use the entire cover on outside mounts.
- On inside mounts, trim the cover along a score to fit over the portion of the headrail that protrudes from the window frame.

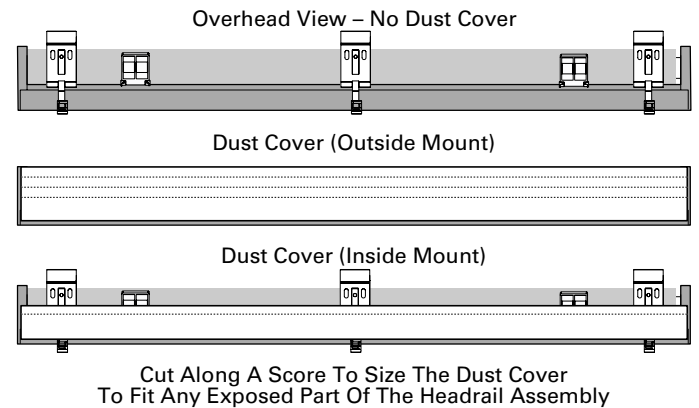

- Cut the cover to fit between extension brackets, when used.
- Peel the backing from the double-sided tape to attach the cover to the headrail.

Attach The Hold-Down Brackets (Optional)

Hold-down brackets secure the bottom rail to the sill when the window shading is fully lowered. The bottom rail can still pivot when opening and closing the vanes, but the shading cannot be raised.

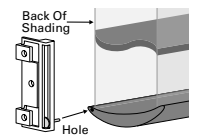

- With the shading fully lowered, insert the pin on the hold-down bracket into the hole on the bottom rail end cap.
- Mark the mounting hole locations on the mounting surface.
- Center the hold-down brackets over the mounting hole locations and check their alignment. Attach using two screws.

NOTE: Disconnect the bottom rail from the hold-down brackets to raise the shading.

6 Remove The Shading

- Fully raise the shading.
- Use the quick release card to release the locking tab on the mounting brackets and remove the shading from the brackets.

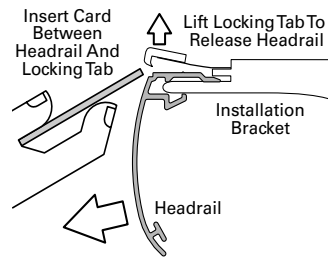

7 Care And Cleaning

Silhouette® window shadings are made of 100% polyester, which means they are inherently durable and resilient. However, care must be taken to avoid wrinkling the fabric, particularly where the vanes meet the facings.

The Palette™ Fabric-Covered Headrail

Hand wash using a sponge or delicate cloth and mild soap solution; handle with care as you would any fine fabrics.

- Do not hand wash The Matisse Collection™ fabric-covered headrail. Lightly dust with a clean, dry cloth.

Dusting

Regular light dusting with a feather duster is all the cleaning that is needed in most circumstances.

Vacuuming

Use a low suction, hand-held vacuum for more thorough dust removal.

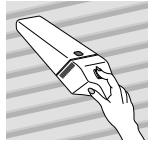

Forced Air

Blow away dirt and debris between the vanes using clean compressed air or a hair dryer set on a “cool” setting.

Spot-Cleaning

Do not spot-clean Silhouette window shadings.

Ultrasonic Cleaning

Silhouette shadings can be ultrasonically cleaned by a professional, with the exception of Bon Soir™ light-dimming fabric.

- Specify that a mild detergent solution be used.
- Never immerse the headrail in the solution.
- Dry the shading completely in the lowered position.

Electrostatic Cleaning

Do not use electrostatic cleaning devices such as Swiffer™ or Pledge Grab-it™ on any Silhouette window shadings.

For more comprehensive cleaning instructions, call the Hunter Douglas Customer Information Center toll free at:

1-888-501-8364

A Note About Silhouette Fabric

As with all textiles, Silhouette fabric is subject to some variations. Slight wrinkling, puckering, or bowing is inherent to this textile product and should be considered normal, acceptable quality. These characteristics are not usually visible from the front or rear but may be visible from a side angle.

Precautions should be taken to reduce exposure to harsh environmental elements, such as salt air. Continuous exposure through open windows and doors will accelerate the fabric deterioration.

8 Child Safety

⚠ WARNING

To avoid entanglement and strangulation, keep cords out of the reach of young children. Also:

- Move cribs and furniture away from the shading cords.
- Install the enclosed safety cord tensioning device to reduce access to the cords. Installation instructions and components required for securing the cord tensioner are included with each shading.

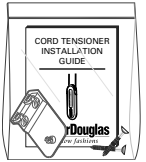

9 Troubleshooting

Problem	Solution
Vanes do not align on side-by-side shadings.	<ul style="list-style-type: none"> • Vane alignment is only guaranteed within 1/4" when shadings are ordered at the same time, at the same height, with the same color, and when specified on the order form. • Check that the windows are square and the same height.
The shading is hard to raise or lower or will not raise or lower.	<ul style="list-style-type: none"> • If an inside mount, check that the shading is installed correctly. Make sure there is clearance between the ends of the shading and the window casement. • Check that the installation brackets are level. Shim to level, if necessary. • If hold-down brackets are used, make sure they have been released. • Make sure the fabric is not caught.
The shading raises or lowers unevenly or the bottom rail is uneven when fully raised.	<ul style="list-style-type: none"> • Check that the window is square by measuring the diagonals. • Check that the installation brackets are level. Shim to level, if necessary. • Adjust the bottom rail weight (see Step 4).
The shading will not snap into the installation brackets.	<ul style="list-style-type: none"> • Check that the installation brackets are aligned and level. • Check that the locking tab on the installation bracket slides over the headrail. See Step 2.



HunterDouglas
window fashions

hunterdouglas.com

Where Great Rooms Begin.

© 1991, 2005 Hunter Douglas Inc. ® Registered trademark of Hunter Douglas Inc.

™ Trademark of Hunter Douglas Inc.

Patented in the U.S. and foreign countries. U.S. and foreign patents pending.

Swiffer™ is a trademark of Procter & Gamble Company.

Pledge Grab-it™ is a trademark of SC Johnson.



PCN 5107211000

rev. 4/05